



User Manual

12 Ports L2 Managed Industrial-Grade Ethernet Switch

ST-IND0804MTS

Packing List

- One Ethernet Switch
- One User Manual
- One Phoenix Terminal
- Din-Rail Mounted Kits

Product description

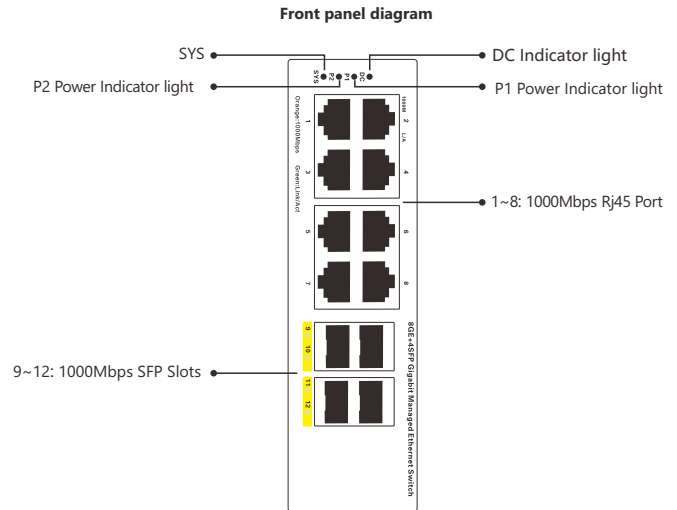

Indicator light	status	Description
PWR	ON	Switch power supply is normal
	OFF	The switch is not powered on or the power supply is abnormal
SYS	ON	The system is working fine
	OFF	The system does not start
1~12	ON	Port is connected
	Flashing	Port is transmitting data
	OFF	The port is not connected, or the connection is abnormal

Side panel diagram

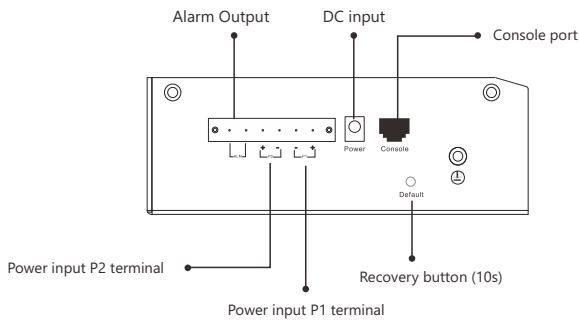

Rear panel diagram

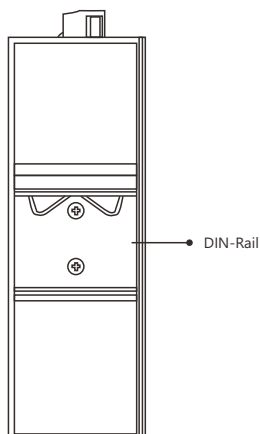

Device installation

Installation Precautions

To avoid damage to the switch or personal injury caused by improper use, please observe the following precautions.

For safety, please do not place the switch near water or damp places, and prevent water or moisture from entering the switch case

- Please ensure that the working environment of the switch is clean. Excessive dust will cause electrostatic adsorption, which will not only affect the life of the equipment, but also easily cause Communication failure
- Please keep the ventilation holes of the switch unblocked, do not stack them
- Please ensure that the switch is working under a correct and stable voltage
- Before using the switch, be sure to reliably ground through the ground terminal on the rear panel of the switch
- Before cleaning the switch, pull out the power plug of the switch. Please do not wipe the switch with damp cloth, and do not use liquid cleaner Wash switch
- Do not open the case when the switch is working. Even when it is not powered.

Install equipment

Industrial switches support two installation methods, desktop installation and DIN rail installation. The following will introduce the two installation methods respectively Specific steps.

Desktop installation

For devices without foot pads in the accessories, you can directly place the switch on a dry and well-grounded workbench.

For the equipment with foot pads in the accessories, the specific installation process is as follows:

- (1) Carefully turn the switch upside down. Clean the grooves on the bottom of the switch chassis with a soft cloth, so that there is no oil or dust adsorption.
- (2) Tear off the adhesive paper on the surface of the foot pad that comes with the machine, and paste the foot pad into the groove on the bottom of the switch chassis.
- (3) Carefully place the switch upright and place it on a clean, stable, and well-grounded workbench.

Rail installation

- (1) Insert the top of the DIN rail into the notch under the rigid metal spring.

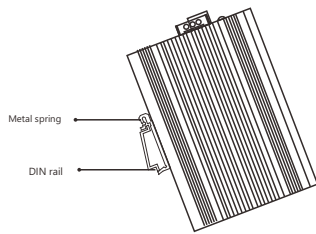

(2) Quickly press the DIN rail base into the position shown in the figure below.

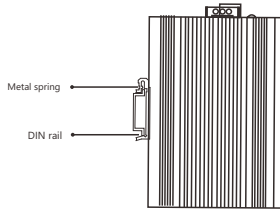

Redundant power input

The switch provides two redundant power inputs, that is, two power inputs of the terminal block. If one power supply fails, the remaining power supply can still be powered to ensure that the switch maintains a normal working state. The two 4-pin wiring terminals on the top board of the switch have two contacts for the two DC inputs of the switch. The schematic diagram of the wiring terminal is shown below.

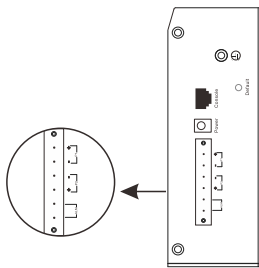

4. Enter the user name and password (the default is admin), and then click the login button.



5. Log in to the web management page of the switch successfully, and you can start to configure the switch.

Specifications

Interface	Down ports 1-8: 10/100/1000M RJ45 Ports Uplink port 9-12: 1000M SFP Slots
Power supply	Phoenix terminal, Dual redundant power supply
Voltage	DC 12-24V
Indicator light	P2, P1, DC, SYS, SFP: Link/Activity indicator
Dimension	153*128*54mm
Installation	DIN-Rail mounted
Network Protocol	IEEE802.3i, IEEE802.3u, IEEE802.3ab IEEE802.3z, IEEE802.3x, IEEE802.1p IEEE802.1x, IEEE802.1d, IEEE802.1s IEEE802.3az
Switching capacity	24Gbps
Packet Forwarding Rate	17.85Mpps
MAC Address Table	8K

1. Insert the negative/positive DC wire into the V-/V+ terminal of the terminal block.
2. In order to prevent the DC wires from loosening, please use a small flat blade screwdriver to tighten the wires in front of the terminals. Clamp the screws.
3. Insert the plastic terminal block connector into the terminal block located on the top plate of the switch.



note

Before connecting the DC power supply to the input of the switch, make sure that the DC power supply voltage is stable.

Log in to the Web GUI

1. Connect the computer to the switch with a network cable.

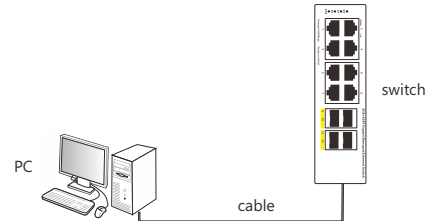

2. Set the computer's local connection IP address to 192.168.1.X (X is 2~254, and is not occupied by other devices), and the subnet mask is 255.255.255.0.
3. Open the computer's local connection browser (take IE as an example), enter <http://192.168.1.1> in the address bar, and press Enter to enter Switch web management page.

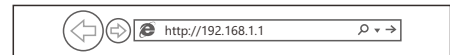

Operating temperature	-40°C ~ +75°C
Stored temperature	-40°C ~ +85°C
Port output maximum power	30W
Relative humidity	5%~95% RH non-condensing
Cooling method	Fanless design, natural heat dissipation
IP grade	IP40
Power surge protection	IEC 61000-4-5 Level X (6KV/6KV)(8/20us)
Network port surge protection	IEC 61000-4-5 Level4 (4KV/4KV)(10/700us)
Radiation immunity	IEC 61000-4-3 Level 3(10V/m)
Instant pulse anti-interference	IEC 61000-4-4 Level 3(1V/2V)
Conducted anti-interference	IEC 61000-4-6 Level 3(10V/m)
Power frequency magnetic field immunity	IEC 61000-4-8 Level 3(30V/m)
Voltage drop	IEC 61000-4-11 Level 3(10V)
Anti-static interference	IEC 61000-4-2 Level 4(8K/15K)

Warranty Card

Model NO.	
Serial NO.	
Purchase Date	
RMA Number	
Return Reason	
Customer Name	
Customer Address	
Customer Email	

Note: Please refer to the User Manual for Detail Warranty policy.